

Parting and grooving

Inserts

General turning

Aluminium
wheel turning

Automatic lathes

Ceramic tools



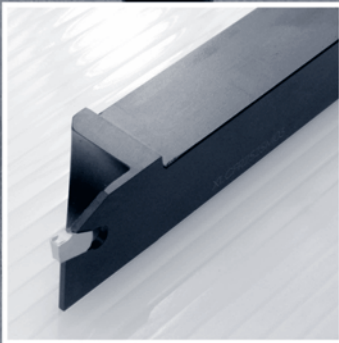
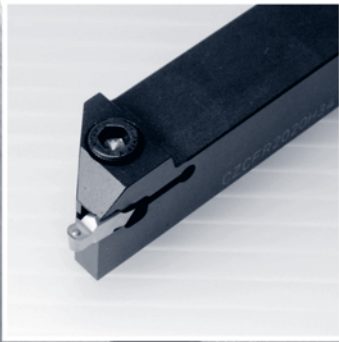









Parting and
grooving



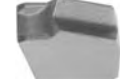

Parting and grooving

Inserts	G.02
Applications	G.07
Toolholders	G.08
Boring bars	G.14
Tool blocks	G.16
Blades	G.17
Notch tools	G.20
Cutting data	G.24

Inserts
General turning
Aluminium wheel turning
Automatic lathes
Ceramic tools
Parting and grooving

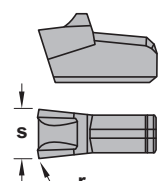
<p>MRCN</p>  <p>Single-ended. Page G.03</p>	<p>MRCR/L</p>  <p>Single-ended. Page G.03</p>	<p>MTE</p>  <p>Single-ended. Page G.03</p>	<p>MTC</p>  <p>Double-ended. Page G.03</p>	<p>MTCJ</p>  <p>Double-ended. Page G.03</p>	<p>MTR</p>  <p>Double-ended. Page G.04</p>	<p>MTRJ</p>  <p>Double-ended. Page G.04</p>
<p>PTNT</p>  <p>Single ended. Page G.04</p>	<p>PTR/LT</p>  <p>Single-ended. Page G.04</p>					
<p>NG</p>  <p>Double-ended For Parting Page G.05</p>	<p>NR</p>  <p>Double-ended For Parting (radius) Page G.05</p>	<p>NT</p>  <p>Double-ended For Threading Page G.06</p>				
<p>ER/L LG</p>  <p>Triangular negative Page G.06</p>						

	Normally available for immediate delivery ● Only available in a limited quantity ○											
	MRCN		s	r	KM15	PM25	PM40	TIN16	TIN17	TIN22	TIN32	ZR10
	MRCN 1.6		1,6	0,15	○	○					●	
	MRCN 2.2		2,2	0,20	○	●					●	○
	MRCN 3.0		3,0	0,20	○	●					●	○
	MRCN 4.0		4,0	0,20	○	●					●	○
	MRCN 5.0		5,0	0,30	○	○					●	○
	MRCN 6.0		6,0	0,40	○						●	○

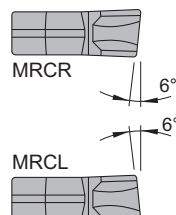
	Normally available for immediate delivery ● Only available in a limited quantity ○											
	MRCR/L		s	r	KM15	PM25	PM40	TIN16	TIN17	TIN22	TIN32	ZR10
	MRCR 3.0		3,0	0,20								○
	MRCR 4.0		4,0	0,20								○
	MRCL 3.0		3,0	0,20								○
	MRCL 4.0		4,0	0,20								○

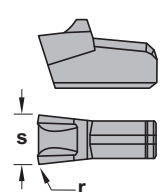
	Normally available for immediate delivery ● Only available in a limited quantity ○											
	MTE		s	r	KM15	PM25	PM40	TIN16	TIN17	TIN22	TIN32	ZR10
	MTE 3.0		3,0	0,20								●
	MTE 4.0		4,0	0,20								●

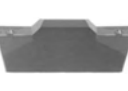
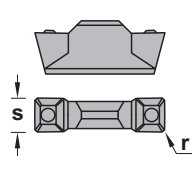
	Normally available for immediate delivery ● Only available in a limited quantity ○											
	MTC		s	r	KM15	PM25	PM40	TIN16	TIN17	TIN22	TIN32	ZR10
	MTC 3.0		3,0	0,15	●	●					○	
	MTC 4.0		4,0	0,20	●	●					●	

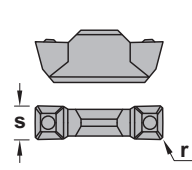
	Normally available for immediate delivery ● Only available in a limited quantity ○											
	MTCJ		s	r	KM15	PM25	PM40	TIN16	TIN17	TIN22	TIN32	ZR10
	MTCJ 3.0		3,0	0,15	●	●					●	
	MTCJ 4.0		4,0	0,20	●	●					●	

Parting and grooving
Threading
Drills
Cartridges
Brazed tools
Tooling

Inserts

General turning

Aluminium wheel turning

Automatic lathes

Ceramic tools

Parting and grooving

 MTR	Normally available for immediate delivery ● Only available in a limited quantity ○									
	s	r	KM15	PM25	PM40	TIN16	TIN17	TIN22	TIN32	ZR10
MTR 3.0	3,0	1,50	○	○					○	
MTR 3.8	3,8	1,90	○	○					○	

 MTRJ	Normally available for immediate delivery ● Only available in a limited quantity ○									
	s	r	KM15	PM25	PM40	TIN16	TIN17	TIN22	TIN32	ZR10
MTRJ 3.0	3,0	1,50	○	○					○	
MTRJ 3.8	3,8	1,90	○	○					○	

 PTNT	Normally available for immediate delivery ● Only available in a limited quantity ○									
	s	KM15	PM25	PM40	TIN16	TIN17	TIN22	TIN32	ZR10	
PTNT 02	2,10		●	●				●		
PTNT 03	3,10	○	●	●				●		
PTNT 04	4,10		●	●				●		
PTNT 05	5,10	○	○					○		
PTNT 06	6,10	○	○					○		
PTNT 08	8,10			○						
PTNT 09	9,10		○							

 PTR/LT	Normally available for immediate delivery ● Only available in a limited quantity ○									
	s	KM15	PM25	PM40	TIN16	TIN17	TIN22	TIN32	ZR10	
PTRT 03 R8	3,0							○		
PTRT 04 R8	4,0							○		
PTLT 03 R8	3,0							○		
PTLT 04 R8	4,0							○		

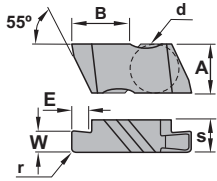
 	Normally available for immediate delivery ●									Only available in a limited quantity ○						
	NG								KM15	PM25	PM40	TIN16	TIN17	TIN22	TIN32	ZR10
	d	A	B	E	r	s	W									
NG-2031R/L	4,76	5,56	6,86	1,27	0,05	3,81	0,79					○				
NG-210R/L	4,76	5,56	6,86	1,27	0,05	3,81	0,99					○				
NG2041R/L	4,76	5,56	6,86	1,27	0,05	3,81	1,04					○				
NG2047R/L	4,76	5,56	6,86	1,27	0,05	3,81	1,19					○				
NG2058R/L	4,76	5,56	6,86	1,27	0,05	3,81	1,47					○				
NG2062R/L	4,76	5,56	6,86	2,79	0,05	3,81	1,57					○				
NG220R/L	4,76	5,56	6,86	2,79	0,05	3,81	2,01					○				
NG2094R/L	4,76	5,56	6,86	2,79	0,05	3,81	2,39					○				
NG230R/L	4,76	5,56	6,86	2,79	0,05	3,81	3,00					○				
NG2125R/L	4,76	5,56	6,86	2,79	0,05	3,81	3,18					○				
NG3031R/L	9,53	8,74	10,29	1,27	0,05	4,95	0,79					○				
NG310R/L	9,53	8,74	10,29	1,27	0,05	4,95	0,99					○				
NG3047R/L	9,53	8,74	10,29	1,91	0,05	4,95	1,19					○				
NG3062R/L	9,53	8,74	10,29	3,05	0,13	4,95	1,57					○				
NG3072R/L	9,53	8,74	10,29	3,05	0,13	4,95	1,83					○				
NG3078R/L	9,53	8,74	10,29	3,05	0,13	4,95	1,98					○				
NG320R/L	9,53	8,74	10,29	3,05	0,13	4,95	2,01					○				
NG3088R/L	9,53	8,74	10,29	3,05	0,13	4,95	2,24					○				
NG3094R/L	9,53	8,74	10,29	4,57	0,13	4,95	2,39					○				
NG3105R/L	9,53	8,74	10,29	4,57	0,13	4,95	2,67					○				
NG3110R/L	9,53	8,74	10,29	4,57	0,13	4,95	2,79					○				
NG330R/L	9,53	8,74	10,29	4,57	0,13	4,95	3,00					○				
NG3122R/L	9,53	8,74	10,29	4,57	0,13	4,95	3,10					○				
NG3125R/L	9,53	8,74	10,29	4,57	0,13	4,95	3,18					○				
NG3142R/L	9,53	8,74	10,29	4,57	0,13	4,95	3,61					○				
NG3156R/L	9,53	8,74	10,29	4,57	0,13	4,95	3,96					○				
NG340R/L	9,53	8,74	10,29	4,57	0,13	4,95	4,01					○				
NG3178R/L	9,53	8,74	10,29	4,57	0,13	4,95	4,52					○				
NG3185R/L	9,53	8,74	10,29	4,57	0,51	4,95	4,70					○				
NG3189R/L	9,53	8,74	10,29	4,57	0,51	4,95	4,80					○				
NG4125R/L	9,53	11,51	16,15	6,35	0,13	6,48	3,18					○				
NG4189R/L	9,53	11,51	16,15	6,35	0,51	6,48	4,80					○				
NG450R/L	9,53	11,51	16,15	6,35	0,25	6,48	5,00					○				
NG4213R/L	9,53	11,51	16,15	6,35	0,13	6,48	5,41					○				
NG4219R/L	9,53	11,51	16,15	6,35	0,51	6,48	5,56					○				
NG4250R/L	9,53	11,51	16,15	6,35	0,51	6,48	6,35					○				
NG4312R/L	9,53	11,51	16,15	6,35	0,76	6,48	7,92					○				
NG6281R/L	9,53	11,51	16,15	6,35	0,76	9,73	7,14					○				
NG6312R/L	9,53	11,51	16,15	6,35	0,76	9,73	7,92					○				
NG6375R/L	9,53	11,51	16,15	6,35	0,76	9,73	9,53					○				

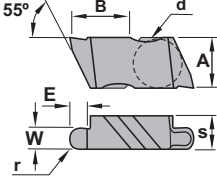
 	Normally available for immediate delivery ●									Only available in a limited quantity ○						
	NR								KM15	PM25	PM40	TIN16	TIN17	TIN22	TIN32	ZR10
	d	A	B	E	r	s	W									
NR2031R/L	4,76	5,56	6,81	2,79	0,79	3,81	1,57					○				
NR2047R/L	4,76	5,56	6,79	2,79	1,19	3,81	2,39					○				
NR2062R/L	4,76	5,56	6,77	2,79	1,57	3,81	3,18					○				
NR3031R/L	9,53	8,74	10,24	3,81	0,79	4,95	1,57					○				
NR3047R/L	9,53	8,74	10,22	3,81	1,19	4,95	2,39					○				
NR3062R/L	9,53	8,74	10,20	3,81	1,57	4,95	3,18					○				
NR3078R/L	9,53	8,74	10,18	3,81	1,98	4,95	3,96					○				
NR3094R/L	9,53	8,74	10,16	3,81	2,39	4,95	4,78					○				
NR4062R/L	9,53	11,51	16,07	6,35	1,57	6,48	3,18					○				
NR4094R/L	9,53	11,51	10,03	6,35	2,39	6,48	4,78					○				
NR4125R/L	9,53	11,51	15,98	6,35	3,18	6,48	6,35					○				

Inserts

General turning

Aluminium wheel turning

Automatic lathes

Ceramic tools

Parting and grooving



Normally available for immediate delivery ●
Only available in a limited quantity ○

NT	d	A	B	E	r	s	KM15	PM25	PM40	TIN16	TIN17	TIN22	TIN32	ZR10
										○	○	○	○	○
NT2R/L	4,76	5,56	6,76	1,91	0,08	3,81				○				
NT3R/L	9,53	8,74	10,16	2,49	0,13	4,95				○				
NT4R/L	9,53	11,51	15,98	3,25	0,13	6,48				○				

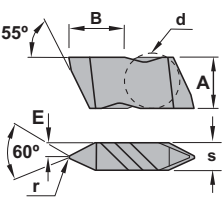

Grooving - External inserts
Lock ring groove inserts type LG

Normally available for immediate delivery ●
Only available in a limited quantity ○



ER-LG

	l	d	W	KM15	PM25	TIN25	TL20
16ER-100LG	16,00	9,52	1,15				●
16ER-120LG	16,00	9,52	1,35				●
16ER-150LG	16,00	9,52	1,65				●
16ER-175LG	16,00	9,52	1,90				●
16ER-200LG	16,00	9,52	2,15				●

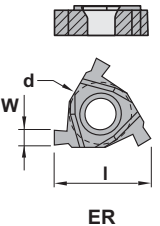

ER

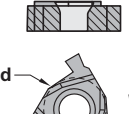

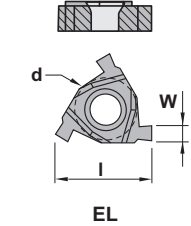

EL-LG

	l	d	W	KM15	PM25	TIN25	TL20
16EL-100LG	16,00	9,52	1,15				●
16EL-120LG	16,00	9,52	1,35				●
16EL-150LG	16,00	9,52	1,65				●
16EL-175LG	16,00	9,52	1,90				●
16EL-200LG	16,00	9,52	2,15				●



EL

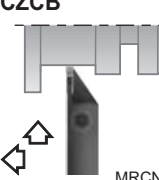
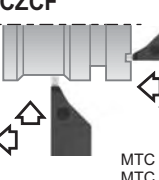
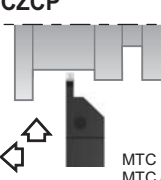
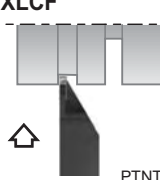

Toolholders

<p>CZGB</p>  <p>Page G.08 MTE 03/04 MRCN 03/04</p>	<p>CZFB</p>  <p>Page G.08 MTE 03/04 MRCN 03/04</p>	<p>CZCB</p>  <p>Page G.10 MRCN 1,6 ... MRCN 6,0</p>	<p>CZCF</p>  <p>Page G.11 MTC 3,0 MTC 4,0 MTR 3,0 MTR 3,8</p>	<p>CZCP</p>  <p>Page G.12 MTC 3,0 MTC 4,0 MTR 3,0 MTR 3,8</p>	<p>XLCF</p>  <p>Page G.13 PTNT 02 PTNT 03 PTNT 04</p>
--	--	---	---	---	---

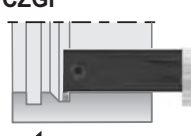
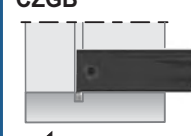

Boring bars

<p>CZGF</p>  <p>Page G.14 MTCJ 3,0 MTCJ 4,0 MTRJ 3,0 MTRJ 3,8</p>	<p>CZGB</p>  <p>Page G.15 MTCJ 3,0 MTCJ 4,0 MTRJ 3,0 MTRJ 3,8</p>				
---	---	--	--	--	--

Tool blocks

<p>CPTS</p>  <p>Page G.16</p>	<p>DPTS</p>  <p>Page G.16</p>				
--	--	--	--	--	--

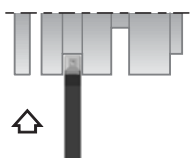
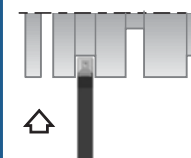
Blades

<p>CRCFN</p>  <p>Page G.17 MRCN 2,2 ... MRCN 6,0</p>	<p>XLCFN</p>  <p>Page G.18 PTNT 02 PTNT 09</p>	<p>XLCTN</p>  <p>Page G.19 PTNT 02 PTNT 06</p>			
--	--	--	--	--	--

Top Notch Tools

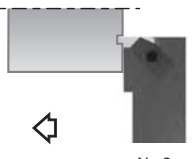
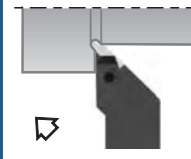
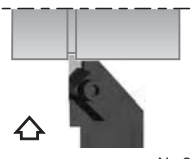
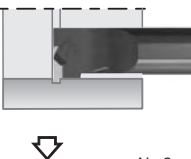
<p>NE 93°</p>  <p>Page G.20 N.. 2 N.. 3 N.. 4</p>	<p>NR 45°</p>  <p>Page G.21 N.. 3</p>	<p>NS 93°</p>  <p>Page G.22 N.. 2 N.. 3 N.. 4</p>	<p>NNTO 93°</p>  <p>Page G.23 N.. 2 N.. 3 N.. 4</p>		
---	---	---	--	--	--

- Inserts
- General turning
- Aluminium wheel turning
- Automatic lathes
- Ceramic tools
- Parting and grooving



Characteristics:

Modular system for inserts with thickness from 3 to 4 mm. The "V" positioning system of the pocket and the clamp integrated to the tool ensure maximum security and repetitivity on the dimensions when the insert is changed.

Applications:

Parting, grooving and face grooving toolholder that works well on steels, alloyed steels, stainless steels and refractories.

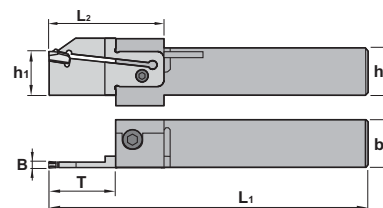

CZGB		h	b	L1	L2	h1	B	T	Kg
Ref.	CZGB R/L 2020 M34	20	20	150	53	20	3-4	25-30	0,600
	CZGB R/L 2525 M34	25	25	150	53	25	3-4	25-30	0,750
	CZGB R/L 3232 P34	32	32	170	53	32	3-4	25-30	1,300

Ref.	CZGB R/L 2020 M34				
	CZGB R/L 2525 M34	1096	1240	5005	5515
	CZGB R/L 3232 P34	1096	1240	5005	5515



Characteristics:

Modular system for inserts with thickness from 3 to 4 mm. The "V" positioning system of the pocket and the clamp integrated to the tool ensure maximum security and repetitivity on the dimensions when the insert is changed.

Applications:

Parting, grooving and face grooving toolholder that works well on steels, alloyed steels, stainless steels and refractories.

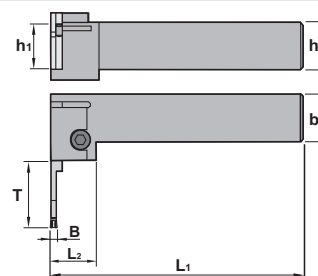



CZFB		h	b	L1	L2	h1	B	T	Kg
Ref.	CZFB R/L 2525 M34	25	25	150	25	25	3-4	25-30	0,750
	CZFB R/L 3232 P34	32	32	170	25	32	3-4	25-30	1,300



Ref.	CZFB R/L 2525 M34				
	CZFB R/L 3232 P34	1096	1240	5005	5515
		1096	1240	5005	5515

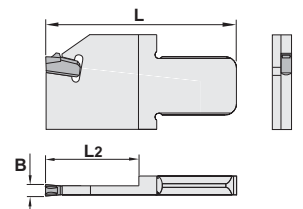



CZXB 00		L	L₂	B	Insert size
Ref.	CZXB R/L 00X03	53	25	3	MRCN 03
	CZXB R/L 00X04	53	25	4	MRCN 04

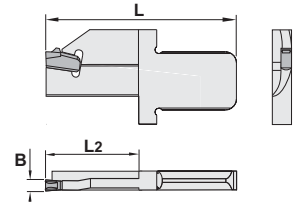

CZXB 40-50		L	L₂	B	Ø Range	Insert size
Ref.	CZXB R/L 4050X03	53	20	3	40 - 50	MTE 03
	CZXB R/L 4050X04	53	20	4	40 - 50	MTE 04

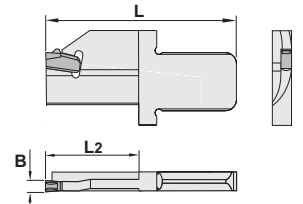

CZXB 50-65		L	L₂	B	Ø Range	Insert size
Ref.	CZXB R/L 5065X03	53	20	3	50 - 65	MTE 03
	CZXB R/L 5065X04	53	20	4	50 - 65	MTE 04

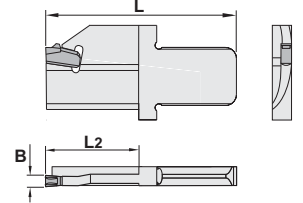

CZXB 65-92		L	L₂	B	Ø Range	Insert size
Ref.	CZXB R/L 6592X03	53	20	3	65 - 92	MTE 03
	CZXB R/L 6592X04	53	20	4	65 - 92	MTE 04

CZXB 90-122		L	L₂	B	Ø Range	Insert size
Ref.	CZXB R/L 90122X03	53	25	3	90 - 122	MTE 03
	CZXB R/L 90122X04	53	25	4	90 - 122	MTE 04

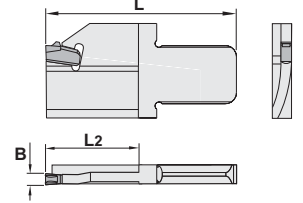

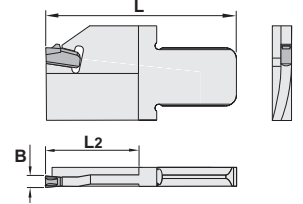

CZXB 120-160		L	L₂	B	Ø Range	Insert size
Ref.	CZXB R/L 120160X03	53	25	3	120 - 160	MTE 03
	CZXB R/L 120160X04	53	25	4	120 - 160	MTE 04

CZXB 150-500		L	L₂	B	Ø Range	Insert size
Ref.	CZXB R/L 150500X03	53	25	3	150 - 500	MTE 03
	CZXB R/L 150500X04	53	25	4	150 - 500	MTE 04

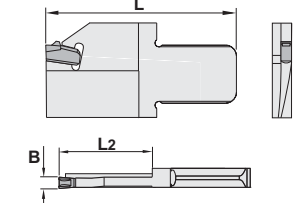

MRCN / MTE		s	r	Single-ended insert for parting and grooving			
Ref.	MRCN 03 / MTE 03	3,0	0,20				
	MRCN 04 / MTE 04	4,0	0,20				
				For more information see page: G.03			
MRCN	MTE						
							

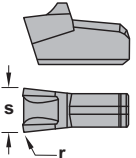

Parting and grooving
Threading
Drills
Cartridges
Braze tools
Tooling

Inserts

General turning

Aluminium wheel turning

Automatic lathes

Ceramic tools

Parting and grooving



Characteristics:

One sided inserts with thickness from 1,6 to 6 mm.

The "V" positioning system of the pocket and the clamp integrated to the tool ensure maximum security and repetitivity on the dimensions when the insert is changed.

Applications:

Parting, grooving and side turning toolholder that works well on steels, alloyed steels, stainless steels and refractories.

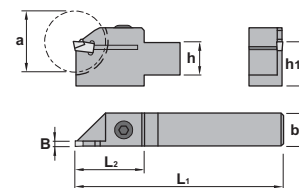
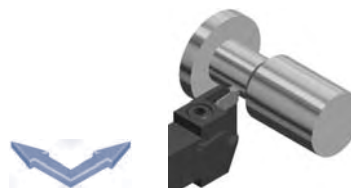



CZCB

Ref.		h	b	L1	L2	h1	B	a	Insert size	Kg
CZCB R/L 1010 J01		10	10	110	25	21	1,6	22	MRCN 1,6	0,080
	CZCB R/L 1010 J02	10	10	110	25	21	2,2	22	MRCN 2,2	0,080
CZCB R/L 1212 J01		12	12	110	25	21	1,6	22	MRCN 1,6	0,100
	CZCB R/L 1212 J02	12	12	110	25	21	2,2	22	MRCN 2,2	0,100
CZCB R/L 1612 J02		16	12	110	29	21	2,2	32	MRCN 2,2	0,150
	CZCB R/L 1612 J03	16	12	110	29	21	3,0	32	MRCN 3,0	0,150
CZCB R/L 2016 K03		20	16	125	35	30	3,0	42	MRCN 3,0	0,350
	CZCB R/L 2016 K04	20	16	125	35	30	4,0	42	MRCN 4,0	0,350
	CZCB R/L 2016 K05	20	16	125	35	30	5,0	42	MRCN 5,0	0,350
	CZCB R/L 2016 K06	20	16	125	35	30	6,0	42	MRCN 6,0	0,350
CZCB R/L 2520 M03		25	20	150	50	30	3,0	80	MRCN 3,0	0,550
	CZCB R/L 2520 M04	25	20	150	50	30	4,0	80	MRCN 4,0	0,550
	CZCB R/L 2520 M05	25	20	150	50	30	5,0	80	MRCN 5,0	0,550
	CZCB R/L 2520 M06	25	20	150	50	30	6,0	80	MRCN 6,0	0,550

Ref.			
CZCB R/L 1010 J01		1905	5004
	CZCB R/L 1010 J02	1905	5004
CZCB R/L 1212 J01		1905	5004
	CZCB R/L 1212 J02	1905	5004
CZCB R/L 1612 J02		1916	5005
	CZCB R/L 1612 J03	1916	5005
CZCB R/L 2016 K03		1906	5005
	CZCB R/L 2016 K04	1906	5005
	CZCB R/L 2016 K05	1906	5005
	CZCB R/L 2016 K06	1906	5005
CZCB R/L 2520 M03		1906	5005
	CZCB R/L 2520 M04	1906	5005
	CZCB R/L 2520 M05	1906	5005
	CZCB R/L 2520 M06	1906	5005

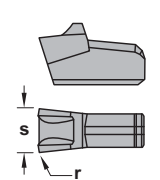
Ref.	MRCN			Single-ended insert for parting and grooving
	s	r		
MRCN 1,6	1,6	0,15		
MRCN 2,2	2,2	0,20		
MRCN 3,0	3,0	0,20		
MRCN 4,0	4,0	0,20		
MRCN 5,0	5,0	0,30		
MRCN 6,0	6,0	0,40		
MRCN				

For more information see page: G.03



Characteristics:

Double sided inserts with thickness from 3 to 4 mm.

The "V" positioning system of the pocket and the clamp integrated to the tool ensure maximum security and repetitivity on the dimensions when the insert is changed.

Applications:

Face grooving and side turning toolholder that works well on steels, alloyed steels, stainless steels and refractories.

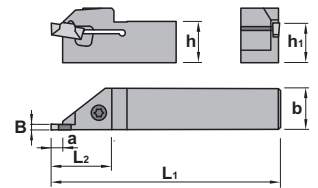

CZCF

Ref.		h=h ₁	b	L ₁	L ₂	B	a	Insert size	Kg
CZCF R/L	CZCF R/L 1616 H34	16	16	100	24	3-4	4,5	MT.. 3,0-4,0	0,200
	CZCF R/L 2020 K34	20	20	125	24	3-4	4,5	MT.. 3,0-4,0	0,300
	CZCF R/L 2525 M34	25	25	150	24	3-4	4,5	MT.. 3,0-4,0	0,450

Ref.			
CZCF R/L	CZCF R/L 1616 H34	1916	5005
	CZCF R/L 2020 K34	1906	5005
	CZCF R/L 2525 M34	1906	5005

	MT..		s	r	Double-ended insert for turning and grooving. For more information see page: G.03
	Ref.				
	MTC				
	MTR				
	MTC				
	MTR				

Inserts

General turning

Aluminium wheel turning

Automatic lathes

Ceramic tools

Parting and grooving



Characteristics:

Double sided inserts with thickness from 3 to 3,8 mm.

The "V" positioning system of the pocket and the clamp integrated to the tool ensure maximum security and repetitivity on the dimensions when the insert is changed.

Applications:

Parting, grooving and side turning toolholder that works well on steels, alloyed steels, stainless steels and refractories.

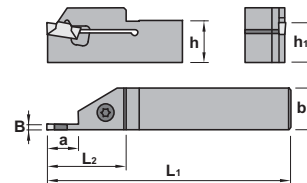
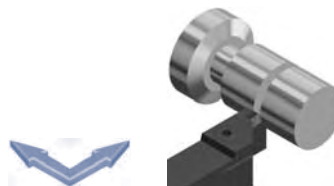

CZCP

Ref.		h=h1	b	L1	L2	B	a	Insert size	Kg
CZCP R/L 1616 H34		16	16	100	30	3-4	12	MT.. 3,0-4,0	0,200
CZCP R/L 2020 K34		20	20	125	30	3-4	12	MT.. 3,0-4,0	0,300
CZCP R/L 2525 M34		25	25	150	30	3-4	12	MT.. 3,0-4,0	0,450

Ref.	CZCP R/L 1616 H34	1916	5005
	CZCP R/L 2020 K34	1906	5005
	CZCP R/L 2525 M34	1906	5005

		MT..	s	r	Double-ended insert for turning and grooving.			
 	Ref.	MTC 3,0	3,0	0,15	For more information see page: G.03			
		MTC 4,0	4,0	0,20				
		MTR 3,0	3,0	1,50				
		MTR 3,8	3,8	1,90				
	MTC	MTR						



Characteristics:

One sided inserts with thickness from 2 to 4 mm.
The "V" positioning system of the pocket and the clamp integrated to the tool ensure maximum security and repetitivity on the dimensions when the insert is changed.

Applications:

Parting and grooving toolholder that works well on steels, alloyed steels, stainless steels and refractories.

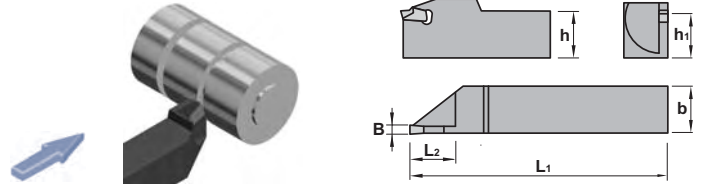

XLCF

Ref.		h=h ₁	b	L ₁	L ₂	B	Insert size	Kg
XLCF R/L 1010 J02		10	10	110	18	2	PTNT 02	0,080
	XLCF R/L 1212 J02	12	12	110	18	2	PTNT 02	0,100
XLCF R/L 1612 J03		16	12	110	20	3	PTNT 03	0,150
	XLCF R/L 1612 J04	16	12	110	20	4	PTNT 04	0,150
XLCF R/L 2012 K03		20	12	125	20	3	PTNT 03	0,200
	XLCF R/L 2012 K04	20	12	125	20	4	PTNT 04	0,200
XLCF R/L 2020 K03		20	20	125	20	3	PTNT 03	0,350
	XLCF R/L 2020 K04	20	20	125	20	4	PTNT 04	0,350
XLCF R/L 2525 M03		25	25	150	20	3	PTNT 03	0,650
	XLCF R/L 2525 M04	25	25	150	20	4	PTNT 04	0,650

Ref.		
XLCF R/L 1010 J02		5732
	XLCF R/L 1212 J02	5732
XLCF R/L 1612 J03		5732
	XLCF R/L 1612 J04	5732
XLCF R/L 2012 K03		5732
	XLCF R/L 2012 K04	5732
XLCF R/L 2020 K03		5732
	XLCF R/L 2020 K04	5732
XLCF R/L 2525 M03		5732
	XLCF R/L 2525 M04	5732

PTNT		s	Single-ended insert for parting and grooving.					
	Ref. PTNT 02	2,10	For more information see page: G.04					
	PTNT 03	3,10						
	PTNT 04	4,10						
	PTNT							

Inserts

General turning

Aluminium wheel turning

Automatic lathes

Ceramic tools

Parting and grooving



Characteristics:

Double sided inserts with thickness from 3 to 4 mm.

The "V" positioning system of the pocket and the clamp integrated to the tool ensure maximum security and repetitivity on the dimensions when the insert is changed.



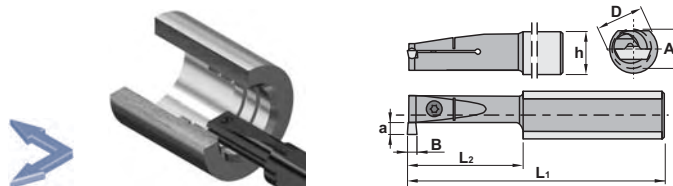

Applications:



Grooving and internal turning toolholder that works well on steels, alloyed steels, stainless steels and refractories.



CZGF

Ref.		D	A	h	L1	L2	B	a	Insert size	kg
S20R CZGF R/L 34		20	16,5	18	200	40	3-4	5	MT.. 3,0-4,0	0,400
S25R CZGF R/L 34		25	25,0	23	200	50	3-4	5	MT.. 3,0-4,0	0,650
S32S CZGF R/L 34		32	30,0	30	250	60	3-4	5	MT.. 3,0-4,0	1,400

Ref.					
S20R CZGF R/L 34		1250	5520	-	-
S25R CZGF R/L 34		-	-	1006	5004
S32S CZGF R/L 34		-	-	1006	5004

Ref.	MT..J					
	MTCJ	MTRJ	s	r		
MTCJ 3,0			3,0	0,15	Double-ended insert for turning and grooving.	
MTCJ 4,0			4,0	0,20		
MTRJ 3,0			3,0	1,50		
MTRJ 3,8			3,8	1,90		
	MTCJ	MTRJ				
						

For more information see page: G.03



Characteristics:

Single sided inserts with thickness from 3 to 4 mm.

The "V" positioning system of the pocket and the clamp integrated to the tool ensure maximum security and repetitivity on the dimensions when the insert is changed.



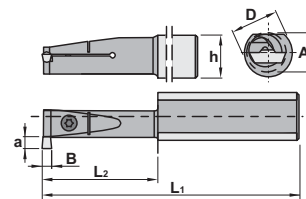

Applications:



Grooving toolholder that works well on steels, alloyed steels, stainless steels and refractories.



CZGB

Ref.		D	A	h	L1	L2	B	a	Insert size	⚖️ Kg
S16M CZGB R/L 03	S16M CZGB R/L 03	16	15,0	15	150	30	3	4	MCRN 3,0	0,180
	S20R CZGB R/L 03	20	16,5	18	200	40	3	6	MCRN 3,0	0,400
	S25S CZGB R/L 03	25	25,0	23	250	50	3	8	MCRN 3,0	0,650
S20R CZGB R/L 04	S20R CZGB R/L 04	20	16,5	18	200	40	4	6	MCRN 4,0	0,400
	S25S CZGB R/L 04	25	25,0	23	250	50	4	8	MCRN 4,0	0,650

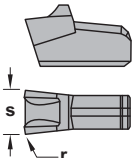
Ref.					
S16M CZGB R/L 03	S16M CZGB R/L 03	1250	5520	-	-
	S20R CZGB R/L 03	1250	5520	-	-
	S25S CZGB R/L 03	-	-	1006	5004
S20R CZGB R/L 04	S20R CZGB R/L 04	-	-	1006	5004
	S25S CZGB R/L 04	-	-	1006	5004

	MRCN			Single-ended insert for parting and grooving
	Ref.	s	r	
	MRCN 3,0	3,0	0,20	For more information see page: G.03
	MRCN 4,0	4,0	0,20	
MRCN				

Parting and grooving
Threading
Drills
Cartridges
Braze tools
Tooling

Inserts

General turning

Aluminium wheel turning

Automatic lathes

Ceramic tools

Parting and grooving





Characteristics:

Tool blocks manufactured with two slot-guide which allows to maintain the blade always guided. The fixing system by flexion ensures good rigidity and security.

Applications:

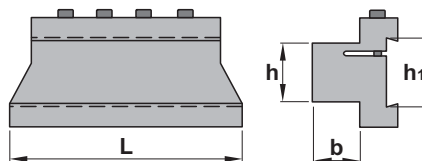
Tool block for manual and C.N.C. lathes.



CPTS								
Ref.		h ₁	L	h	b	kg		
CPTS 1916		19	76	16	16	0,300	1075	5004
CPTS 2616		26	87	16	16	0,450	1076	5005
CPTS 2620		26	87	20	20	0,500	1076	5005
CPTS 2625		26	87	25	25	0,650	1076	5005
CPTS 3220		32	100	20	20	0,700	1076	5005
CPTS 3225		32	110	25	25	0,950	1076	5005
CPTS 3232		32	120	32	32	1,400	1076	5005
CPTS 5250		52	135	50	50	3,400	1078	5006





Characteristics:

Tool blocks manufactured with two slot-guide which allows to maintain the blade always guided. Fixing system in two parts for machines with difficult access.

Applications:

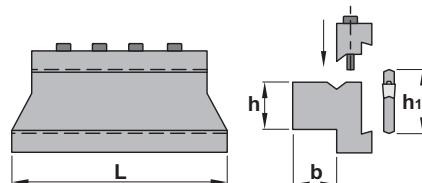
Tool block for manual and C.N.C. lathes.



DPTS								
Ref.		h ₁	L	h	b	kg		
DPTS 1916		19	76	16	16	0,250	1075	5004
DPTS 2620		26	87	20	20	0,550	1076	5005
DPTS 2625		26	87	25	25	0,700	1076	5005
DPTS 3220		32	100	20	20	0,750	1076	5005
DPTS 3225		32	110	25	25	1,000	1076	5005
DPTS 3232		32	120	32	32	1,450	1076	5005
DPTS 5250		52	135	50	50	3,450	1078	5006

Characteristics:

One sided inserts with thickness from 2,2 to 6 mm.

The double "V" pocket ensures a reliable and repetitive insert positioning and centering.

Available in 4 sizes (19, 26 and 32).

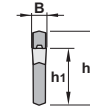
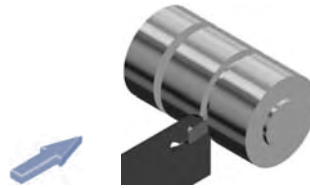

Applications:

Parting and grooving blade that works well on steels, alloyed steels, stainless steels and refractories.

**CRCFN**

Ref.		h	L	h1	B	Insert size	 Kg
CRCF N 1901 X02		19	86	15,4	2,2	MRCN 2,2	0,040
CRCF N 2601 J02		26	110	21,4	2,2	MRCN 2,2	0,060
CRCF N 2602 J03		26	110	21,4	3,0	MRCN 3,0	0,070
CRCF N 2603 J04		26	110	21,4	4,0	MRCN 4,0	0,090
CRCF N 2604 J05		26	110	21,4	5,0	MRCN 5,0	0,100
CRCF N 2605 J06		26	110	21,4	6,0	MRCN 6,0	0,100
CRCF N 3202 M03		32	150	25,0	3,0	MRCN 3,0	0,100
CRCF N 3203 M04		32	150	25,0	4,0	MRCN 4,0	0,125
CRCF N 3204 M05		32	150	25,0	5,0	MRCN 5,0	0,150
CRCF N 3205 M06		32	150	25,0	6,0	MRCN 6,0	0,170

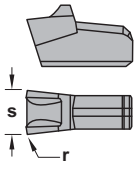
Ref.		
CRCF N 1901 X02		5733
CRCF N 2601 J02		5733
CRCF N 2602 J03		5733
CRCF N 2603 J04		5733
CRCF N 2604 J05		5733
CRCF N 2605 J06		5733
CRCF N 3202 M03		5733
CRCF N 3203 M04		5733
CRCF N 3204 M05		5733
CRCF N 3205 M06		5733

		MRCN	s	r	Single-ended insert for parting and grooving
	Ref.	MRCN 2,2	2,2	0,20	For more information see page: G.03
		MRCN 3,0	3,0	0,20	
		MRCN 4,0	4,0	0,20	
		MRCN 5,0	5,0	0,30	
		MRCN 6,0	6,0	0,40	
	MRCN				
					

Inserts

General turning

Aluminium wheel turning

Automatic lathes

Ceramic tools

Parting and grooving

Characteristics:

One sided inserts with thickness from 2 to 9 mm.
The double "V" pocket ensures a reliable and repetitive insert positioning and centering.
Available in 4 sizes (19, 26, 32 and 53).

Applications:

Parting, grooving blade that works well on steels, alloyed steels, stainless steels and refractories.

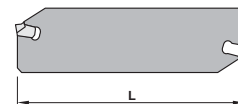
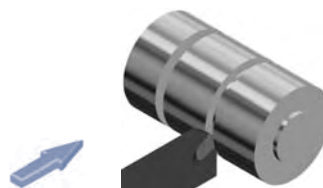

XLCFN							
Ref.		h	L	B	Insert size	kg	
XLCF N 1901 X02		19	86	2,1	PTNT 02	0,040	5732
XLCF N 2601 J02		26	110	2,1	PTNT 02	0,050	5732
XLCF N 2602 J03		26	110	3,1	PTNT 03	0,050	5732
XLCF N 2603 J04		26	110	4,1	PTNT 04	0,085	5732
XLCF N 2604 J05		26	110	5,1	PTNT 05	0,095	5732
XLCF N 2605 J06		26	110	6,1	PTNT 06	0,120	5732
XLCF N 3201 M02		32	150	2,1	PTNT 02	0,075	5732
XLCF N 3202 M03		32	150	3,1	PTNT 03	0,100	5732
XLCF N 3203 M04		32	150	4,1	PTNT 04	0,130	5732
XLCF N 3204 M05		32	150	5,1	PTNT 05	0,160	5732
XLCF N 3205 M06		32	150	6,1	PTNT 06	0,190	5732
XLCF N 3207 M08		32	150	8,1	PTNT 08	0,230	5732
XLCF N 3208 M09		32	150	9,1	PTNT 09	0,270	5732
XLCF N 5207 X08		53	190	8,1	PTNT 08	0,500	5732
XLCF N 5208 X09		53	190	9,1	PTNT 09	0,600	5732
XLCF N 5307 X08		53	260	8,1	PTNT 08	0,700	5732
XLCF N 5308 X09		53	260	9,1	PTNT 09	0,800	5732

PTNT		s	Single-ended insert for parting and grooving.			
Ref.	PTNT 02	2,10	For more information see page: G.04			
	PTNT 03	3,10				
	PTNT 04	4,10				
	PTNT 05	5,10				
	PTNT 06	6,10				
	PTNT 08	8,10				
	PTNT 09	9,10				
	PTNT					

Characteristics:

Positive stop blade for inserts with thickness from 2 to 6 mm.
The double "V" pocket ensures a reliable and repetitive insert positioning and centering.
Available in 4 sizes (19, 26, and 32).

Applications:

Parting, grooving blade that works well on steels, alloyed steels, stainless steels and refractories.

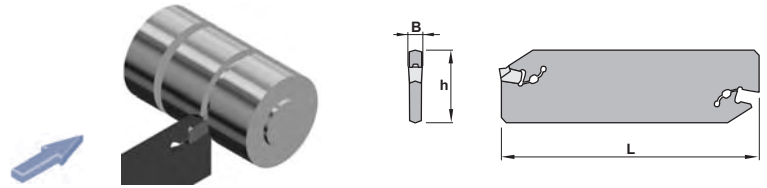

XLCTN

Ref.		h	L	B	Insert size	Kg
XLCT N 1901 X02		19	86	2,1	PTNT 02	0,040
XLCT N 2601 J02		26	110	2,1	PTNT 02	0,050
XLCT N 2602 J03		26	110	3,1	PTNT 03	0,050
XLCT N 2603 J04		26	110	4,1	PTNT 04	0,085
XLCT N 2604 J05		26	110	5,1	PTNT 05	0,095
XLCT N 2605 J06		26	110	6,1	PTNT 06	0,120
XLCT N 3201 M02		32	150	2,1	PTNT 02	0,075
XLCT N 3202 M03		32	150	3,1	PTNT 03	0,100
XLCT N 3203 M04		32	150	4,1	PTNT 04	0,130
XLCT N 3204 M05		32	150	5,1	PTNT 05	0,160
XLCT N 3205 M06		32	150	6,1	PTNT 06	0,190

Ref.		
XLCT N 1901 X02		5732
XLCT N 2601 J02		5732
XLCT N 2602 J03		5732
XLCT N 2603 J04		5732
XLCT N 2604 J05		5732
XLCT N 2605 J06		5732
XLCT N 3201 M02		5732
XLCT N 3202 M03		5732
XLCT N 3203 M04		5732
XLCT N 3204 M05		5732
XLCT N 3205 M06		5732

PTNT		s	Single-ended insert for parting and grooving.			
Ref.	PTNT 02	2,10	For more information see page: G.04			
	PTNT 03	3,10				
	PTNT 04	4,10				
	PTNT 05	5,10				
	PTNT 06	6,10				
	PTNT					

Inserts

General turning

Aluminium wheel turning

Automatic lathes

Ceramic tools

Parting and grooving

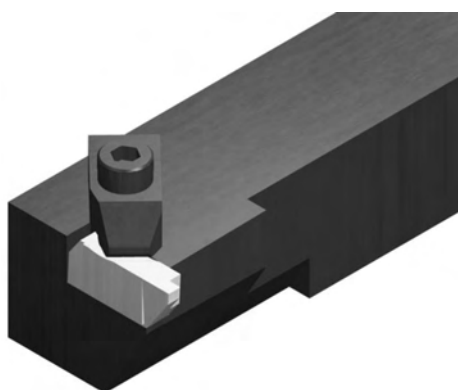

Characteristics:

Multipurpose grooving and threading top clamp toolholder.
Right tools require left inserts and vice versa.
Maximum grooving depth depending on insert.

Applications:

External/internal grooving toolholder.

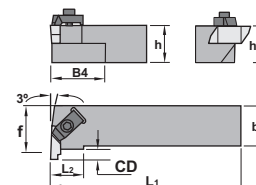

NE 93°

Ref.		h=h ₁	b	L ₁	L ₂	f	Insert size	Kg
NE R/L 1616 H02	NE R/L 1616 H02	16	16	100	25,40	20	N..2	0,200
	NE R/L 2020 K02	20	20	125	25,40	25	N..2	0,400
	NE R/L 2525 M02	25	25	150	25,40	32	N..2	0,700
NE R/L 2525 M03	NE R/L 2525 M03	25	25	150	50,80	32	N..3	0,700
	NE R/L 3225 P03	32	25	170	50,80	32	N..3	1,000
NE R/L 2525 M04	NE R/L 2525 M04	25	25	150	50,80	35	N..4	0,700
	NE R/L 3225 P04	32	25	170	50,80	35	N..4	1,000
NE R/L 3232 P04	NE R/L 3232 P04	32	32	170	50,80	40	N..4	1,250

Ref.		R	L	
NE R/L 1616 H02	NE R/L 1616 H02	TF-75	TF-74	1494
	NE R/L 2020 K02	TF-75	TF-74	1494
	NE R/L 2525 M02	TF-75	TF-74	1494
NE R/L 2525 M03	NE R/L 2525 M03	TF-73	TF-72	1495
	NE R/L 3225 P03	TF-73	TF-72	1495
NE R/L 2525 M04	NE R/L 2525 M04	TF-73	TF-72	1495
	NE R/L 3225 P04	TF-73	TF-72	1495
NE R/L 3232 P04	NE R/L 3232 P04	TF-73	TF-72	1495

Ref.	N..	D	A	T	
Ref.	N.. 2	4,76	5,56	3,81	NG: Insert for parting NR: Insert for parting with radius NT: Insert for threading
	N.. 3	9,53	8,74	4,95	
	N.. 4	9,53	11,51	6,48	
	NG	NR	NT		

For more information see page: G.05



Characteristics:

Specific application grooving toolholder.
Right tools require left inserts and vice versa.
Maximum grooving depth depending on insert.

Applications:

External grooving toolholder.

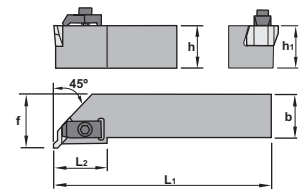

NR 45°

Ref.		h=h1	b	L1	L2	f	Insert size	Kg
Ref.	NR R/L 2020 K03	20	20	125	32	25	N..3	0,400
	NR R/L 2525 M03	25	25	150	32	32	N..3	0,700
	NR R/L 3225 P03	32	25	170	32	32	N..3	1,000

Ref.		R	L	
Ref.	NR R/L 2020 K03	TF-73	TF-72	1495
	NR R/L 2525 M03	TF-73	TF-72	1495
	NR R/L 3225 P03	TF-73	TF-72	1495

 	N..				NG: Insert for parting NR: Insert for parting with radius NT: Insert for threading For more information see page: G.05
	Ref.	D	A	T	
	N.. 3	9,53	8,74	4,95	
	NG	NR	NT		

Inserts

General turning

Aluminium wheel turning

Automatic lathes

Ceramic tools

Parting and grooving

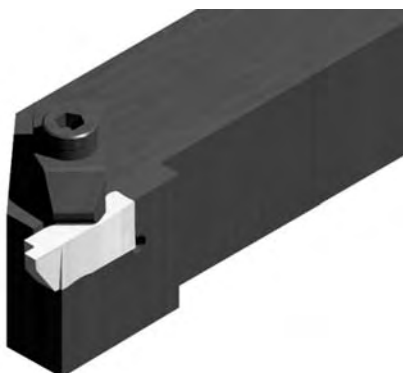

Characteristics:
Multipurpose grooving and threading top clamp toolholder.
Maximum grooving depth depending on insert.

Applications:
External grooving toolholder.

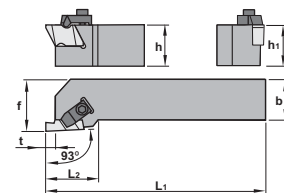

NS 93°

Ref.		h=h ₁	b	L ₁	L ₂	f	Insert size	Kg
NS R/L	1010 E02	10	10	70	6,35	14	N..2	0,070
	1212 F02	12	12	80	6,35	16	N..2	0,100
	1616 H02	16	16	100	6,35	20	N..2	0,200
	2020 K02	20	20	125	6,35	25	N..2	0,400
	2525 M02	25	25	150	6,35	32	N..2	0,700
	2020 K03	20	20	125	9,65	25	N..3	0,400
	2525 M03	25	25	150	9,65	32	N..3	0,700
	3225 P03	32	25	170	9,65	32	N..3	0,900
	3232 P03	32	32	170	9,65	40	N..3	1,250
	2525 M04	25	25	150	9,65	32	N..4	0,700
3225 P04	32	25	170	9,65	32	N..4	0,900	
3232 P04	32	32	170	9,65	40	N..4	1,250	

Ref.		R	L			
NS R/L	1010 E02	TF-74	TF-75	-	-	1494
	1212 F02	TF-74	TF-75	-	-	1494
	1616 H02	TF-74	TF-75	-	-	1494
	2020 K02	TF-74	TF-75	-	-	1494
	2525 M02	TF-74	TF-75	-	-	1494
NS R/L	2020 K03	TF-72	TF-73	-	-	1495
	2525 M03	TF-72	TF-73	-	-	1495
	3225 P03	TF-72	TF-73	-	-	1495
	3232 P03	TF-72	TF-73	-	-	1495
	2525 M04	TF-72	TF-73	3521	1625	1495
3225 P04	TF-72	TF-73	3521	1625	1495	
3232 P04	TF-72	TF-73	3521	1625	1495	

Ref.	N..	D	A	T	
Ref.	N.. 2	4,76	5,56	3,81	NG: Insert for parting NR: Insert for parting with radius NT: Insert for threading
	N.. 3	9,53	8,74	4,95	
	N.. 4	9,53	11,51	6,48	
	NG	NR	NT		

For more information see page: G.05





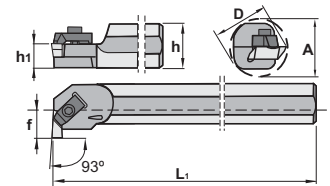



Characteristics:
 Multipurpose grooving and threading top clamp boring bar.
 Right tools require left inserts and vice versa.
 Maximum grooving depth depending on insert.
Applications:
 Internal grooving toolholder.

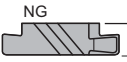
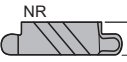
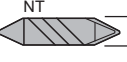

NNTO 93°

Ref.		D	h	h1	L1	f	A	Insert size	kg
Ref.	A12M-NNTO R/L 02	12	11	5,5	150	11	18,5	N..2	0,150
	A16M-NNTO R/L 02	16	15	7,5	150	11	22,0	N..2	0,200
	A20Q-NNTO R/L 02	20	18	9,0	180	13	26,0	N..2	0,400
	A25R-NNTO R/L 02	25	23	11,5	200	17	34,0	N..2	0,700
	A25R-NNTO R/L 03	25	23	11,5	200	17	34,0	N..3	0,700
	A32S-NNTO R/L 03	32	30	15,0	250	22	44,0	N..3	1,400
	A40T-NNTO R/L 03	40	37	18,5	300	27	54,0	N..3	2,650
	A40T-NNTO R/L 04	40	37	18,5	300	27	54,0	N..4	2,650
	A50U-NNTO R/L 04	50	47	23,5	350	35	70,0	N..4	5,400

Ref.		 R	 L	
Ref.	A12M-NNTO R/L 02	TF-147	TF-146	1494
	A16M-NNTO R/L 02	TF-75	TF-74	1494
	A20Q-NNTO R/L 02	TF-75	TF-74	1494
	A25R-NNTO R/L 02	TF-75	TF-74	1494
	A25R-NNTO R/L 03	TF-73	TF-72	1495
	A32S-NNTO R/L 03	TF-73	TF-72	1495
	A40T-NNTO R/L 03	TF-73	TF-72	1495
	A40T-NNTO R/L 04	TF-73	TF-72	1495
	A50U-NNTO R/L 04	TF-73	TF-72	1495

	N..	D	A	T	
  	Ref.	N.. 2	4,76	5,56	3,81
		N.. 3	9,53	8,74	4,95
		N.. 4	9,53	11,51	6,48
	NG	NR	NT		
					

NG: Insert for parting
 NR: Insert for parting with radius
 NT: Insert for threading

For more information see page: G.05

Nominal cutting speed for parting

Material	HB	Condition	Basic qualities			Specific cutting force N/mm ²
			TIN32	PM25	KM15	
			Cutting speed m/min.			
Unalloyed steel P	125	C=0.15%	200-150	160-120		1900
	150	C=0.35%	190-140	150-110		2100
	200	C=0.60%	170-120	130-90		2250
Low alloyed steel	180	Annealed	180-130	140-100		2100
	275	Hardened	160-110	120-80		2600
	300	Hardened	150-100	110-70		2700
	350	Hardened	140-90	90-60		2850
High alloyed steel	200	Annealed	110-90	70-60		2600
	325	Hardened	70-50	45-30		3900
Stainless steel	200	Martensitic/Ferritic	170-120	130-90		2300
Steel	180	Unalloyed	130-90	100-60		2000
	200	Low alloyed	115-75	90-50		2500
	225	High alloyed	100-60	80-40		2700
Stainless steel annealed M	180		170-120	130-90	100-60	2450
Heat resistant alloys	200	Annealed			50-30	3000
	280	Aged				
	250	Annealed				
	350	Aged				
	320	Cast				
Titanium alloys	400	Ti				1520
	950	Cast α , almost α and $\alpha + \beta$				
	1050	Aged cast $\alpha + \beta$				
Hardened steel K	220	Hardened steel				4500
	250	Manganese steel 12%				
Malleable cast iron	130	Ferritic	140-110		100-80	1100
	230	Pearlitic	100-70		70-50	1100
Cast iron	180	Low tensile strength	110-85		80-60	1100
	260	High tensile strength	100-70		70-50	1500
Nodular SG iron	160	Ferritic	100-70		70-50	1100
	250	Pearlitic	85-60		60-40	1800
Aluminium alloys	60	Non heat treatable	1500	1500	1000	500
	100	Heat treatable	500	500	420	800
Aluminium alloys (cast)	75	Non heat treatable	1500	1500	1000	750
	90	Heat treatable	750	750	650	900
Bronze-Brass alloys	110	Lead alloys, Pb>1%	300	300	300	700
	90	Brass, red brass	200	200	200	750
	100	Bronze and lead-free copper	150	150	150	1750

Nominal cutting speed for grooving

Material	HB	Condition	External			Internal / Axial			Specific cutting force N/mm ²				
			TIN32	PM25	KM15	TIN32	PM25	KM15					
			Cutting speed m/min.										
Unalloyed steel P	125	C=0.15%	200-150	160-120		140-105	110-85		1900				
	150	C=0.35%	190-140	150-110		135-100	105-80		2100				
	200	C=0.60%	170-120	130-90		120-85	90-60		2250				
Low alloyed steel	180	Annealed	180-130	140-100		125-90	100-70		2100				
	275	Hardened	160-110	120-80		110-80	85-55		2600				
	300	Hardened	150-100	110-70		105-70	80-50		2700				
	350	Hardened	140-90	90-60		100-60	60-45		2850				
High alloyed steel	200	Annealed	110-90	70-60		80-60	50-45		2600				
	325	Hardened	70-50	45-30		80-35	32-20		3900				
Stainless steel	200	Martensitic/Ferritic	170-120	130-90		120-85	90-60		2300				
Steel	180	Unalloyed	130-90	100-60		90-60	70-45		2000				
	200	Low alloyed	115-75	90-50		80-50	60-35		2500				
	225	High alloyed	100-60	80-40		70-45	55-30		2700				
Stainless steel annealed M	180		170-120	130-90	100-60	120-85	90-60	70-45	2450				
Heat resistant alloys	200	Annealed											
	280	Aged								Iron base	50-30	50-30	3000
	250	Annealed								Ni or Co base	40-20	40-20	3050
	350	Aged									30-20	30-20	3500
	320	Cast									20-10	20-10	4150
Titanium alloys	400	Ti			175				1520				
	950	Cast α , almost α and $\alpha + \beta$			72				1675				
	1050	Aged cast $\alpha + \beta$			65				1690				
Hardened steel K	220 250	Hardened steel Manganese steel 12%							4500				
Malleable cast iron	130	Ferritic	140-110		100-80	100-80		100-80	1100				
	230	Pearlitic	100-70		70-50	70-50		70-50	1100				
Cast iron	180	Low tensile strength	110-85		80-60	80-60		80-60	1100				
	260	High tensile strength	100-70		70-50	70-50		70-50	1500				
Nodular SG iron	160	Ferritic	100-70		70-50	70-50		70-50	1100				
	250	Pearlitic	85-60		60-40	60-45		60-40	1800				
Aluminium alloys	60	Non heat treatable	1500	1500	1000	1050	1050	700	500				
	100	Heat treatable	500	500	420	350	350	300	800				
Aluminium alloys (cast)	75	Non heat treatable	1500	1500	1000	1050	1050	700	750				
	90	Heat treatable	750	750	650	525	525	460	900				
Bronze-Brass alloys	110	Lead alloys, Pb>1%	300	300	300	210	210	210	700				
	90	Brass, red brass	200	200	200	140	140	140	750				
	100	Bronze and lead-free copper	150	150	150	105	105	105	1750				

Nominal cutting speed for profiling

Material	HB	Condition	Basic qualities			Specific cutting force N/mm ²
			TIN32	PM25	KM15	
			Cutting speed m/min.			
Unalloyed steel P	125	C=0.15%	200	160		1900
	150	C=0.35%	190	150		2100
	200	C=0.60%	170	130		2250
Low alloyed steel	180	Annealed	180	140		2100
	275	Hardened	160	120		2600
	300	Hardened	150	110		2700
	350	Hardened	140	90		2850
High alloyed steel	200	Annealed	130	100		2600
	325	Hardened	100	60		3900
Stainless steel	200	Martensitic/Ferritic	170	130		2300
Steel	180	Unalloyed	130	100		2000
	200	Low alloyed	115	90		2500
	225	High alloyed	100	70		2700
Stainless steel annealed M	180		170	120	100	2450
Heat resistant alloys	200	Annealed			60	3000
	280	Aged			50	3050
	250	Annealed			30	3500
	350	Aged			20	4150
	320	Cast			20	4150
Titanium alloys	400	Ti			175	1520
	950	Cast α , almost α and $\alpha + \beta$			72	1675
	1050	Aged cast $\alpha + \beta$			65	1690
Hardened steel K	220	Hardened steel				4500
	250	Manganese steel 12%				
Malleable cast iron	130	Ferritic	140		100	1100
	230	Pearlitic	110		70	1100
Cast iron	180	Low tensile strength	110		100	1100
	260	High tensile strength	100		70	1500
Nodular SG iron	160	Ferritic	100		100	1100
	250	Pearlitic	85		70	1800
Aluminium alloys	60	Non heat treatable	1500	1500	1000	500
	100	Heat treatable	500	500	420	800
Aluminium alloys (cast)	75	Non heat treatable	1500	1500	450	750
	90	Heat treatable	750	750	300	900
Bronze-Brass alloys	110	Lead alloys, Pb>1%	300	300	300	700
	90	Brass, red brass	200	200	200	750
	100	Bronze and lead-free copper	150	150	150	1750

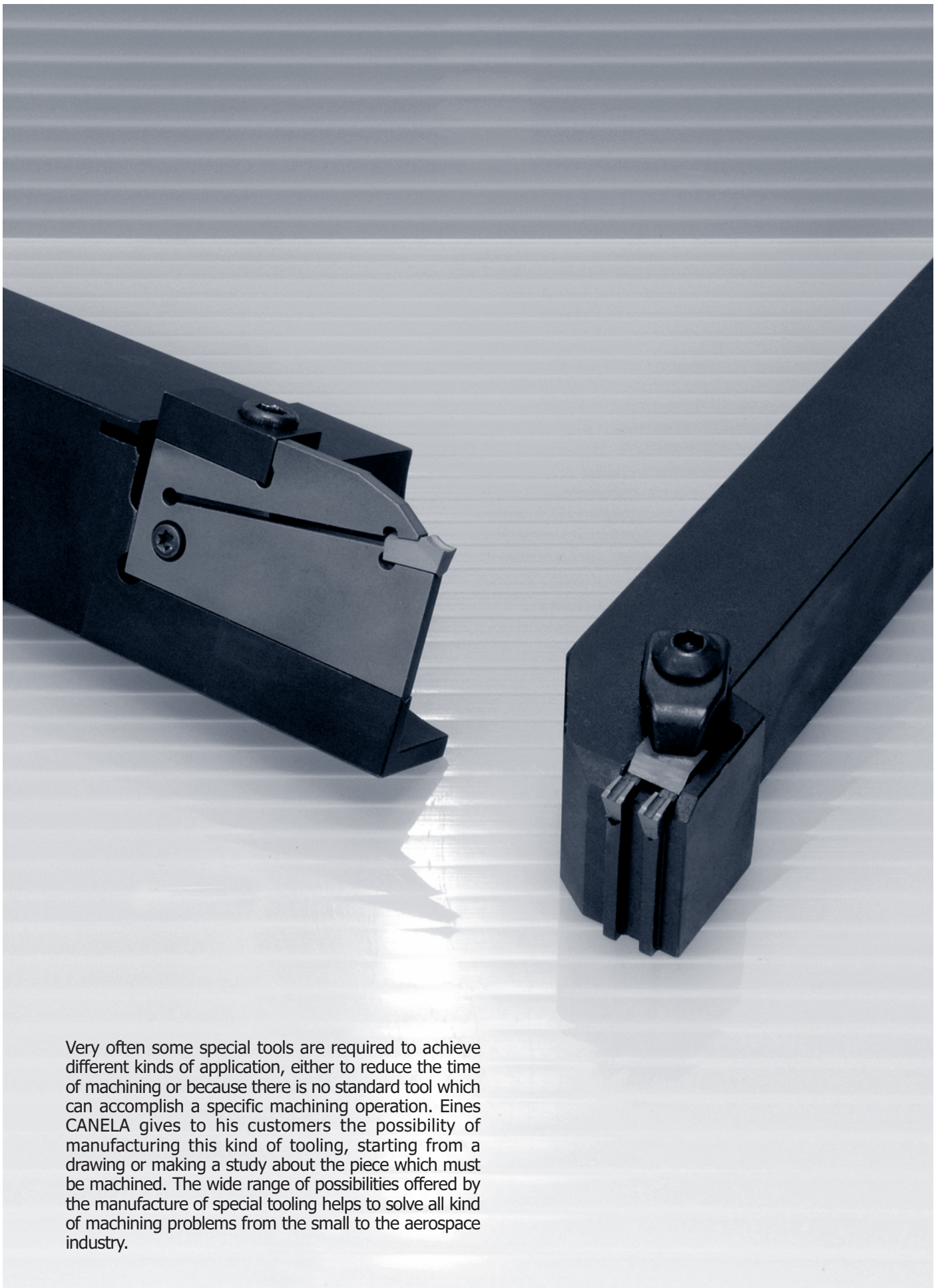

Very often some special tools are required to achieve different kinds of application, either to reduce the time of machining or because there is no standard tool which can accomplish a specific machining operation. Eines CANELA gives to his customers the possibility of manufacturing this kind of tooling, starting from a drawing or making a study about the piece which must be machined. The wide range of possibilities offered by the manufacture of special tooling helps to solve all kind of machining problems from the small to the aerospace industry.